

MACK®

PIONEER™

THIS IS THE NEW STANDARD.





THIS IS
THE NEW
STANDARD.

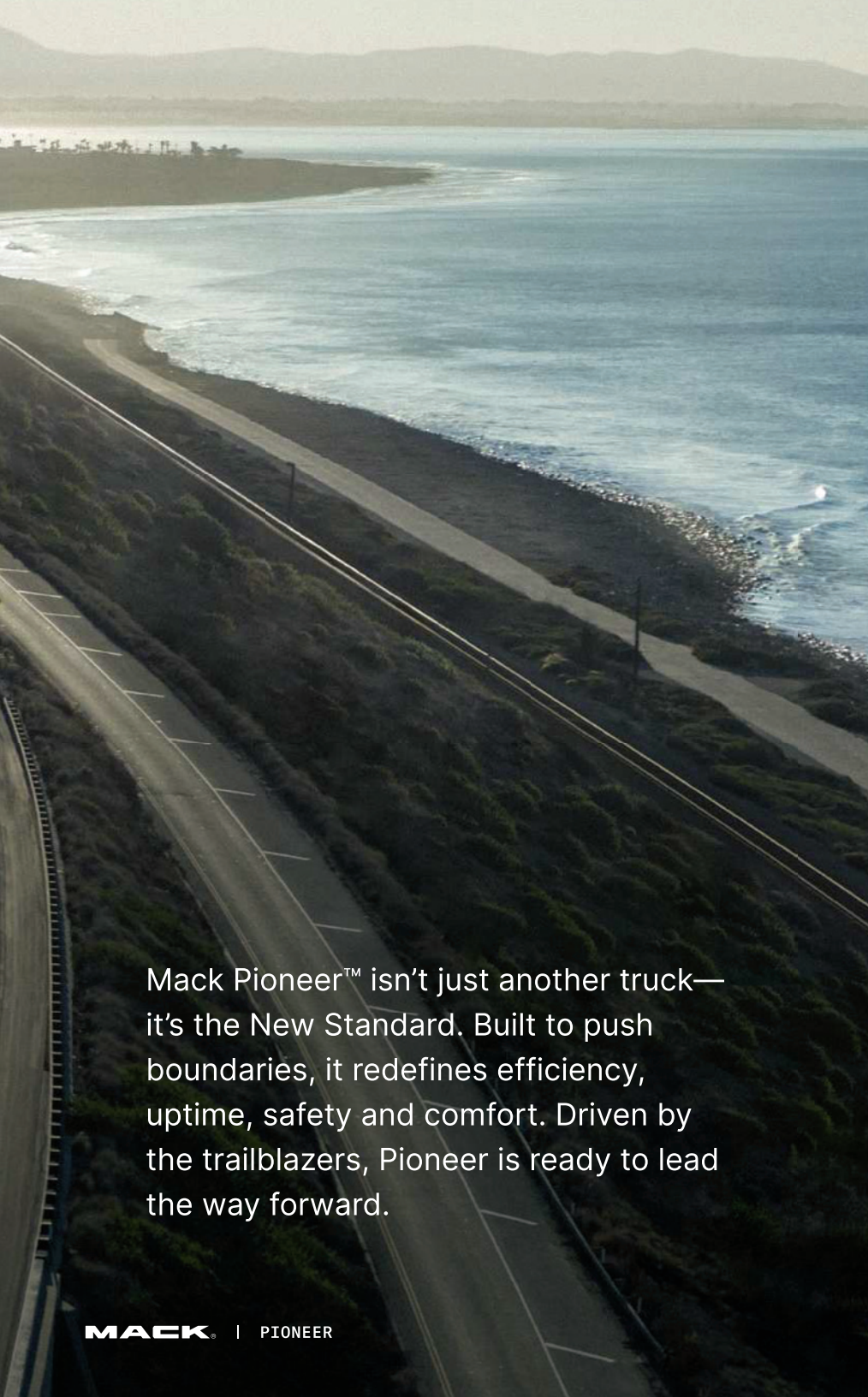

Mack Pioneer™ isn't just another truck—it's the New Standard. Built to push boundaries, it redefines efficiency, uptime, safety and comfort. Driven by the trailblazers, Pioneer is ready to lead the way forward.

Table of Contents

Pioneer Overview	04
------------------	----

Cab Configurations	10
--------------------	----

Aerodynamics / Exterior	12
-------------------------	----

Powertrain	14
------------	----

Driver Comfort	18
----------------	----

Safety	24
--------	----

Integrated Uptime	28
-------------------	----

Support	32
---------	----

DESIGNED
WITH EVERY
DETAIL IN MIND.

THIS IS THE NEW STANDARD.

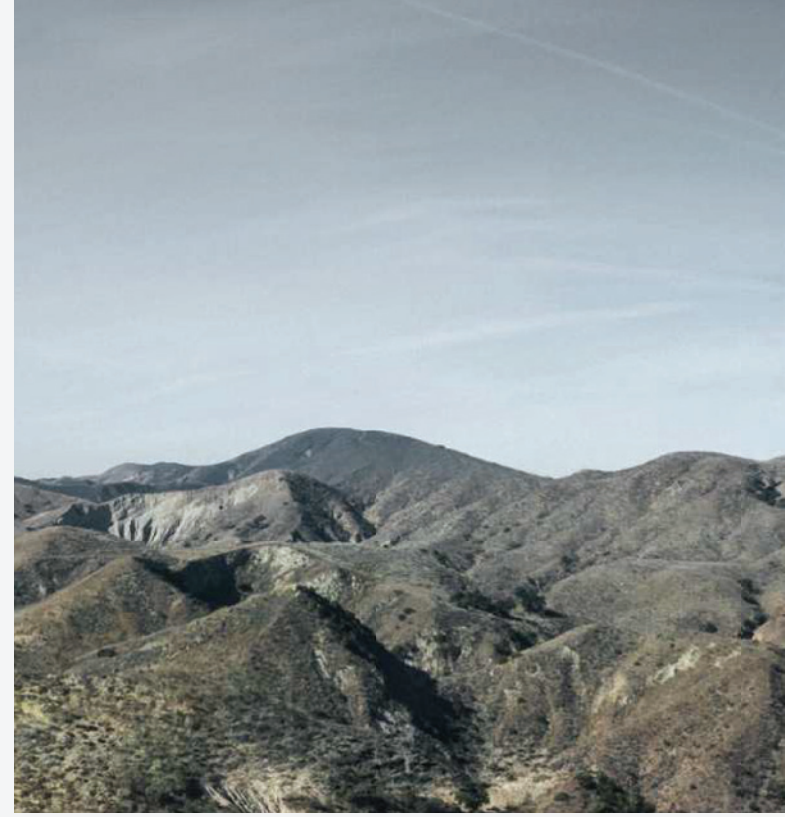



We built our legacy by setting new standards in trucking, and the Mack Pioneer™ is no exception. Designed from the ground up to redefine performance, Pioneer is the result of deep industry insight, cutting-edge engineering, and a relentless focus on the driver.



Every detail—from its aerodynamic contours to its driver-centric interior—was crafted to push efficiency, comfort, and uptime further than ever before.





This is more than a new truck. It's a breakthrough in long-haul design, setting a new standard for what fleets and drivers should expect.



CHROME PAINTED SHOWN

CAB
CONFIGURATIONS
THAT DON'T
COMPROMISE.

THIS IS THE NEW STANDARD.



Cab Configurations

All Mack Pioneer™ configurations shown with optional roof fairing.



Day Cab

125" BBC. 12'6" or 13'6" overall height with roof fairing options.



44-Inch Mid Roof Sleeper

157" BBC. 13'6" overall height with roof fairing.



64-Inch Mid Roof Sleeper

177" BBC. 13'6" overall height with roof fairing.



76-Inch Mid Roof Sleeper

189" BBC. 13'6" overall height with roof fairing.



76-Inch High Roof Sleeper

189" BBC. 13'6" overall height with roof fairing.

Explore select paint colors and exterior options through the Mack Trucks configurator at: macktrucks.com/trucks/build/

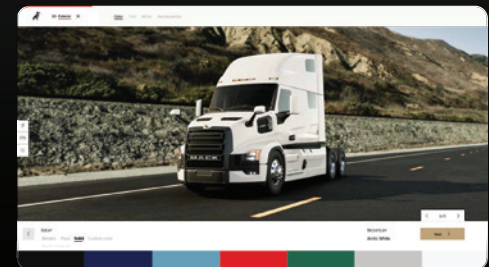

AERODYNAMICS
THAT DEFY
THE WIND.

THIS IS THE NEW STANDARD.

Efficiency

Mack Pioneer™ breaks new barriers for efficiency with up to 11% better fuel economy through enhancements to aerodynamics and the powertrain.



New Aero Max Package

Combines the full set of Pioneer's aerodynamic options for maximum efficiency and fuel economy.

- Extra-Low Chassis Ground Effects
- Over 12" Enhanced Cab Extenders
- Roof Deflector with Trim Tab
- Wheel Covers

1. Inset Bulldog

Recessed bulldog hood ornament reduces wind drag while keeping the iconic Bulldog front and center.

2. Three-Piece Hood

Designed for aerodynamics, bold styling, and replacement of individual sections in the event of damage.

3. Mack Aero Windshield

Improves fuel economy and visibility while adding strength to the cab.

4. Digital Mirror System (DMS)

Real-time digital views that replicate traditional mirrors for enhanced visibility and safety.

5. Front and Rear Wheel Closeouts

Creates a clean aerodynamic flow to push air around the wheels.

6. Chassis Fairings

New fully-enclosed cab skirt and fairings smooth airflow with covered fuel and DEF tank access.

7. Wider Cab

9 inches of additional width streamlines airflow and creates a spacious driver environment.

8. Cab Side Deflectors

Streamlined design improves performance by enabling smoother air flow from the cab to the trailer.

MORE POWER.
MORE FUEL
EFFICIENCY.

THIS IS THE NEW STANDARD.



New Mack MP[®]13 Engine

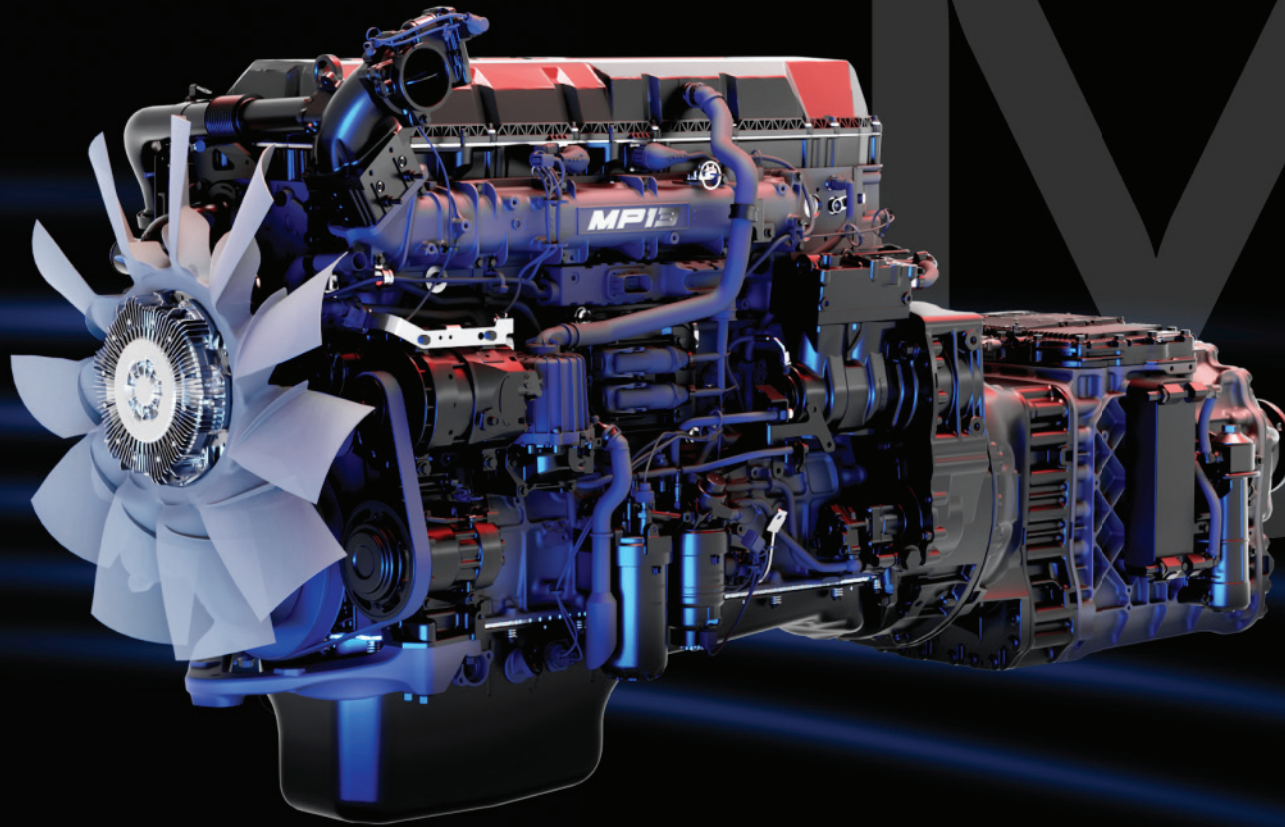

Greater Power

Delivering up to 515hp and up to 1,950 lb-ft of torque, the MP13 is available in a variety of ratings to power any haul. Choose the MP13HE for maximum efficiency, or the MP13 for versatile power across a variety of terrains.

Greater Fuel Efficiency

Engineered to deliver unprecedented fuel economy, the MP13 engine features a new wave piston design and other combustion improvements that make it 3% more fuel efficient than the MP8 engine.

Dynamic Overdrive

Specially engineered for the MP13 engine, the 13-speed Dynamic Overdrive technology intelligently shifts between Economy+, Economy, and Performance modes, delivering optimal efficiency while enhancing startability and hill climbing.

Enhanced Engine Brake

An updated engine brake curve gives the Mack PowerLeash™ engine brake the capability to deliver maximum braking power.

New Mack *mDRIVE*[™] Transmission

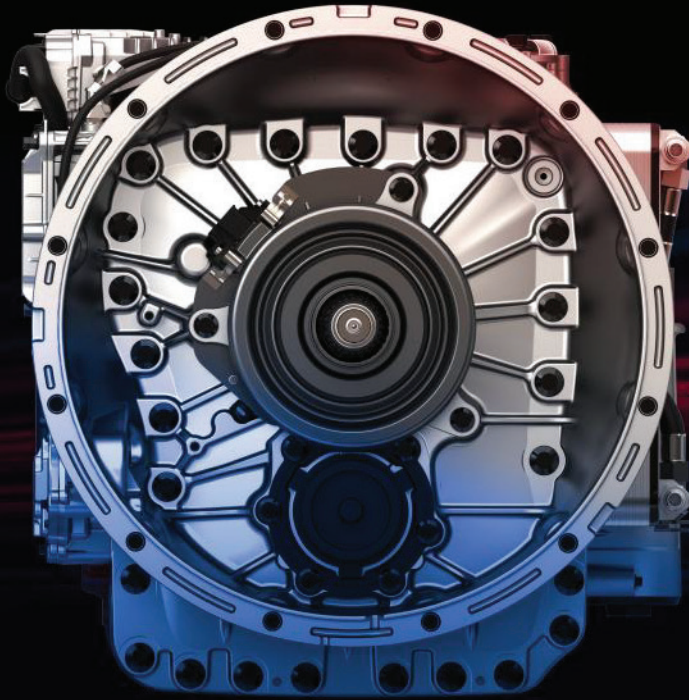

mDRIVE[™]

Enhanced Electronics

mDRIVE[™] utilizes new hardware sensors and valves to improve gear shifting performance.

New Clutch Design

A redesigned clutch features a new disc, clutch housing, and dampening control system for enhanced durability.

30% Faster Shifting

The optimized transmission design provides shifting that's faster and smoother than ever.



PIIONEER

CABIN
COMFORT
THAT RAISES
THE BENCHMARK.

THIS IS THE NEW STANDARD.

Spacious Interior Cab

With an exceptionally spacious interior that provides plenty of room in both the driver's area and the sleeper, Pioneer's ergonomic layout ensures comfort and ease of movement.

THE MOST SPACIOUS
CABIN WE'VE EVER BUILT

WEDGE-SHAPED CAB
INCREASES WIDTH AT THE
DRIVER'S SHOULDERS

ELITE TRIM SHOWN

Spacious Interior Cab

Mack Pioneer™ breaks new ground for interior cabin and sleeper space.



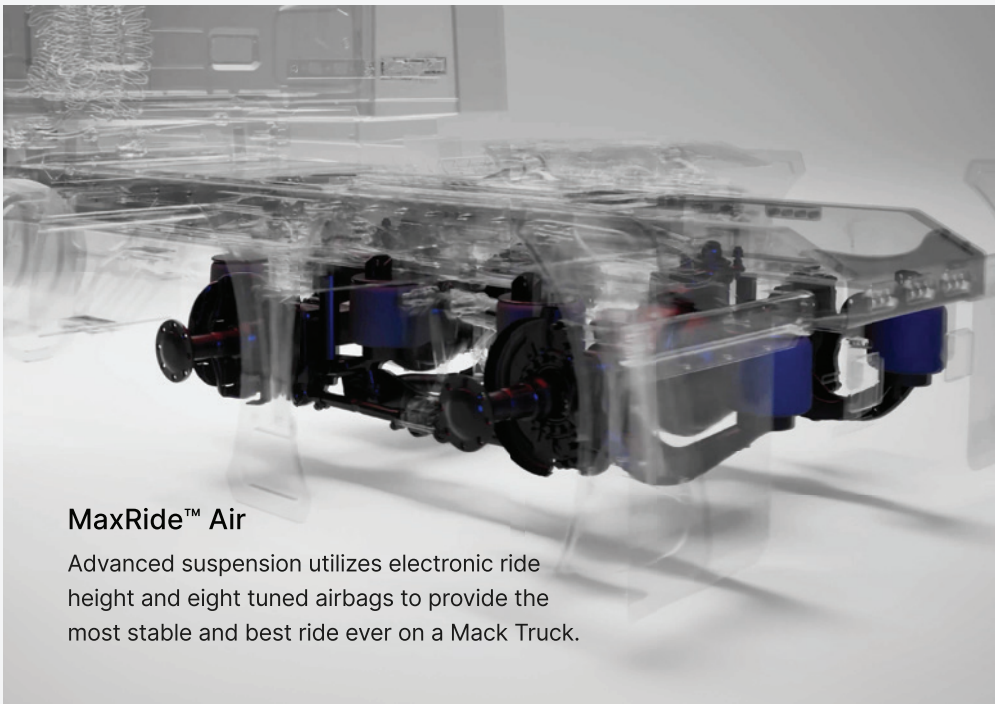

MaxRide™ Air

Advanced suspension utilizes electronic ride height and eight tuned airbags to provide the most stable and best ride ever on a Mack Truck.



Flat-Bottom Steering Wheel

A flat-bottom wheel allows more room where it counts. Smart steering wheel buttons access infotainment and cruise control.



Stalk Located *mDRIVE*™ Controls

Positioned for easy access, the shifter allows for smooth, intuitive gear changes without taking hands off the wheel.



Mack CoPilot™ Display

New 12" digital instrument cluster and 9" infotainment display option offer critical information and intuitive navigation.

Mack® Command Steer

A highly advanced active steering system, Command Steer can help reduce driver effort up to 85% and improve driver productivity and comfort.

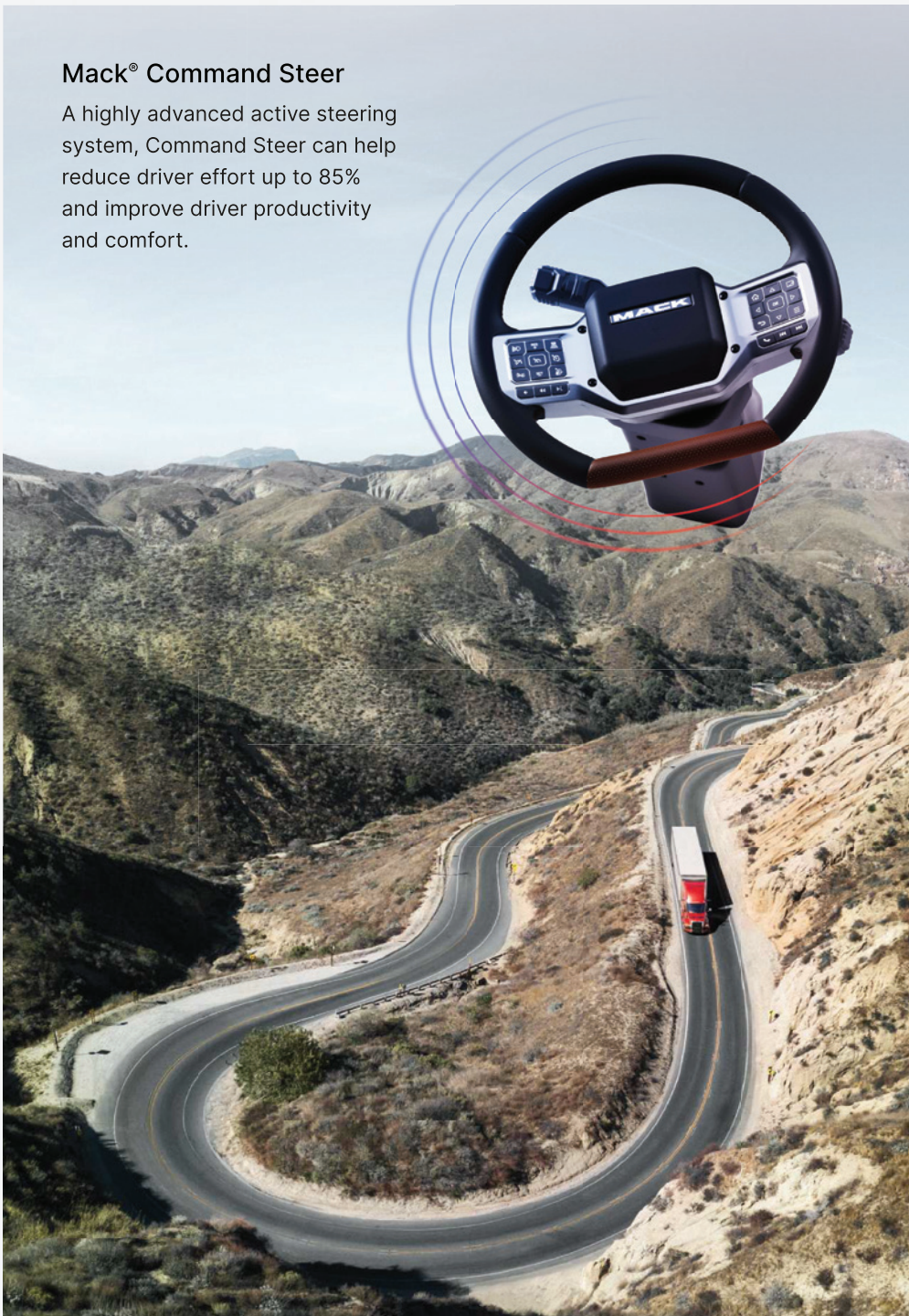

Mack Integrated Parking Cooler

A new optional parking cooler features an integrated design that maintains a comfortable cabin environment without idling the truck's engine, greatly reducing fuel costs.



Standard Wide Base and High-Back Seat

Designed for all-day comfort, Pioneer's seating keeps drivers refreshed on long hauls and features available options for heating, cooling, and massage.

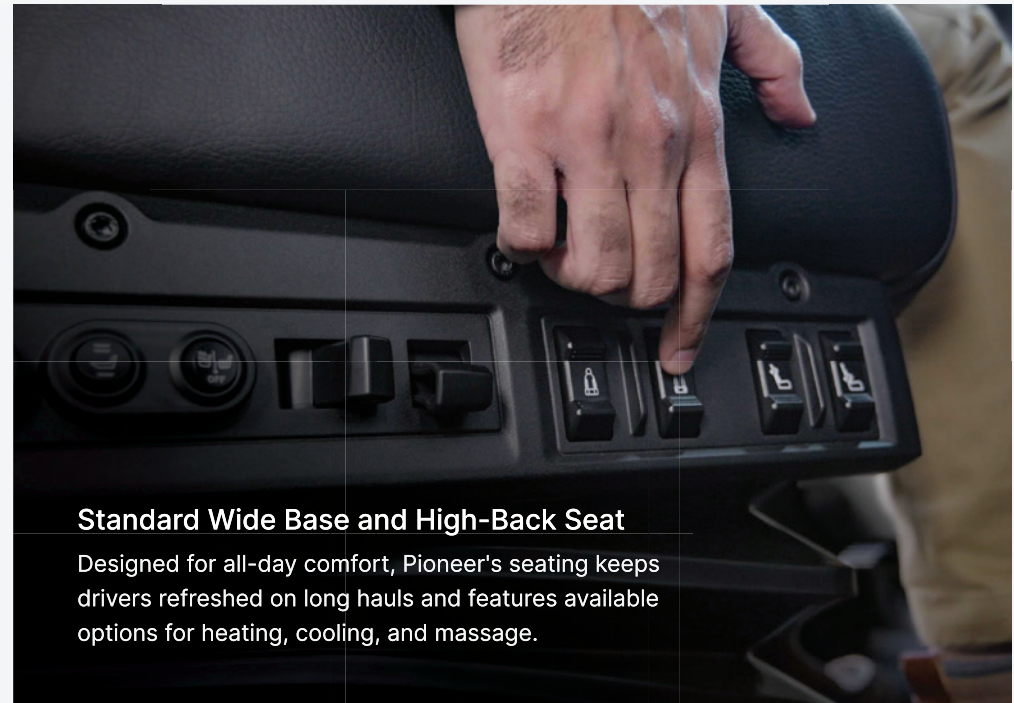

Customize Your Interior

Mack Pioneer™ is built for the long haul—and designed for the way you work. Choose from a range of trim packages, sleeper configurations, and smart storage solutions to create a truck that fits your needs.

- 1. Door Panel
- 2. Door Panel Accent Trim
- 3. Steering Wheel
- 4. Dash Topper
- 5. Dash Highlight Accent
- 6. Interior Panels & Cabinets

Comfort Trim

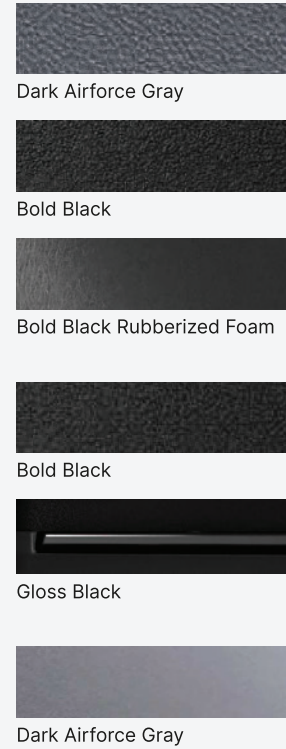

Preferred Trim

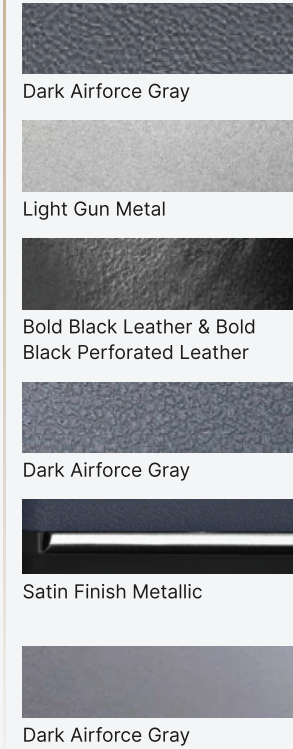

Elite Trim

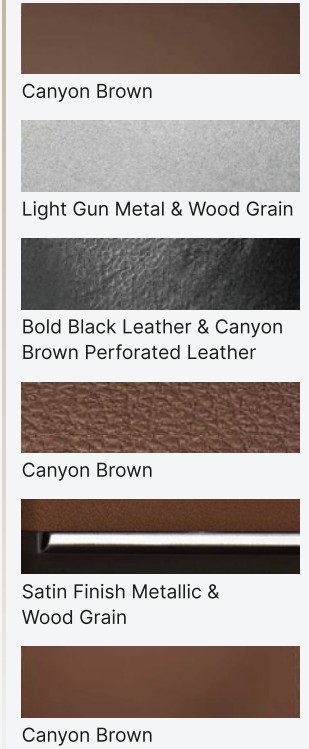

SAFETY
THAT LOOKS
AHEAD, BEYOND
AND BEHIND.

THIS IS THE NEW STANDARD.

Safety

Mack Pioneer™ redefines long-haul safety with advanced collision mitigation technology, durable construction, and smart features that keep drivers protected mile after mile.



New Mack Protect

Combining radars and cameras to detect potential hazards, Mack Protect provides alerts to the driver, and if necessary, it intervenes with braking, engine control, and even corrective steering to help avoid collisions.

Steel Cab

Built for long-term durability and crash protection, the fully welded high-strength steel cab is designed to keep drivers safe and secure.



E-Call 911

Automatically calls emergency services (911) if the deployment of air bags and/or a rollover event is detected.

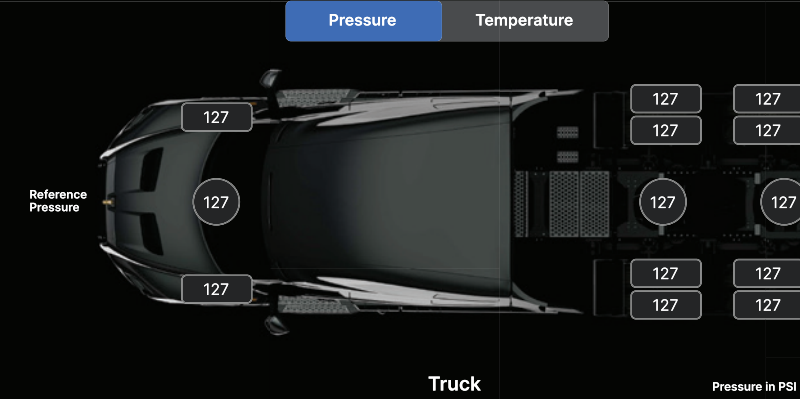
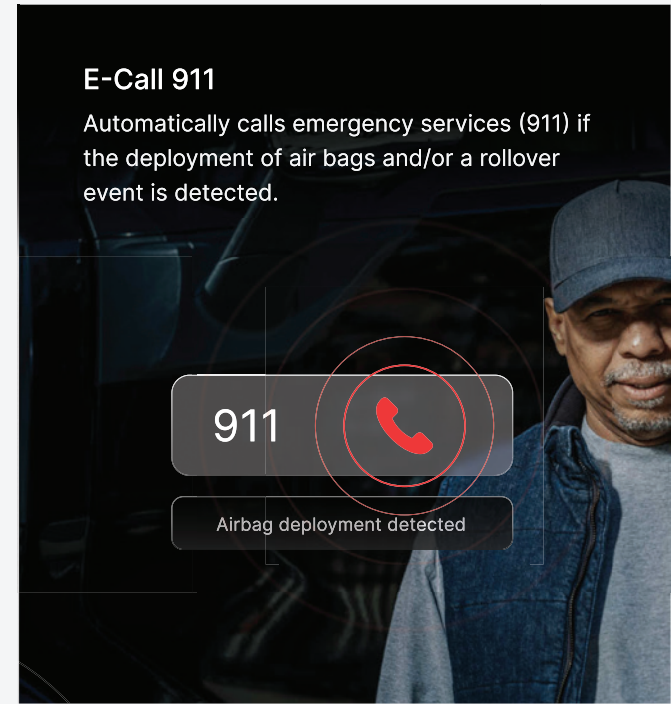

Tire Pressure Monitoring System

Tire wear and consumption can be a major issue for fleets. This factory-fitted option streamlines tire monitoring to get the most out of your tires.

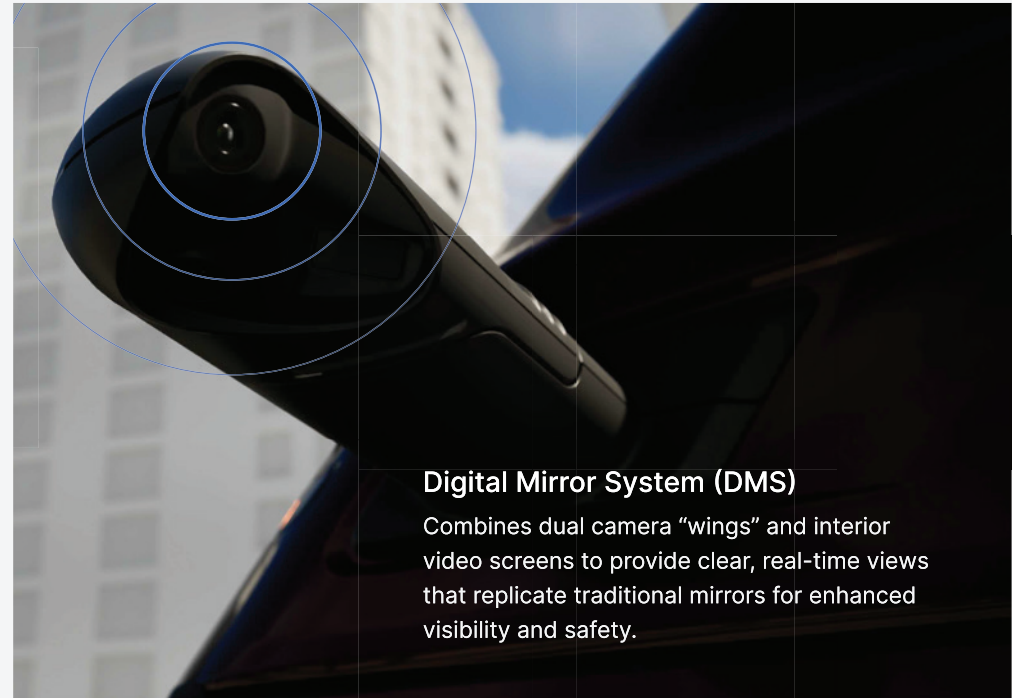

Additional Safety Features

Electropneumatic Braking System (EBS)

Air pressure adapts to different driving conditions, providing smoother, more consistent braking.

Increased Visibility

A new Mack Aero Windshield improves the driver's line of sight and awareness.

Splayed Frame Rails

Designed to enhance crash energy management, providing greater protection for drivers in the event of a collision.

New Front and Side Curtain Airbags

Standard frontal airbag and available side curtain airbags provide an added layer of protection in the event of a collision.

Frontal Collision and Rollover Support

Automatically shuts down engine, unlocks doors, and turns on interior lights to help vehicle occupants safely exit the vehicle after a rollover incident or frontal collision.



UPTIME
WITH
NEXT-LEVEL
INTEGRATIONS.

THIS IS THE NEW STANDARD.



Mack Integrated Uptime

Optimize Mack Pioneer™ with a connected suite of smart, responsive productivity tools. 5 years of Integrated Uptime included with truck purchase.*

*See dealer for details.

Over The Air (OTA) Updates

Upgrade vehicle software and parameters to deliver all the latest improvements, 24/7.

GuardDog® Connect

Automatically monitors your truck to coordinate the right support solution and service scheduling—all while you're still on the job.

OneCall®

Our team at Mack OneCall provides 24/7 full-service support with a network of experts to keep you and your drivers informed and connected ahead of any problem.

ASIST

For on-the-go repair coordination, Mack ASIST assembles consistent, complete and professional estimates of service recommendations.



New My Mack Mobile App

My Mack places on-the-go information and control of your truck right in the palm of your hand. Remotely control and schedule climate functions, check your fuel levels, and monitor other key performance indicators—all from one convenient location.

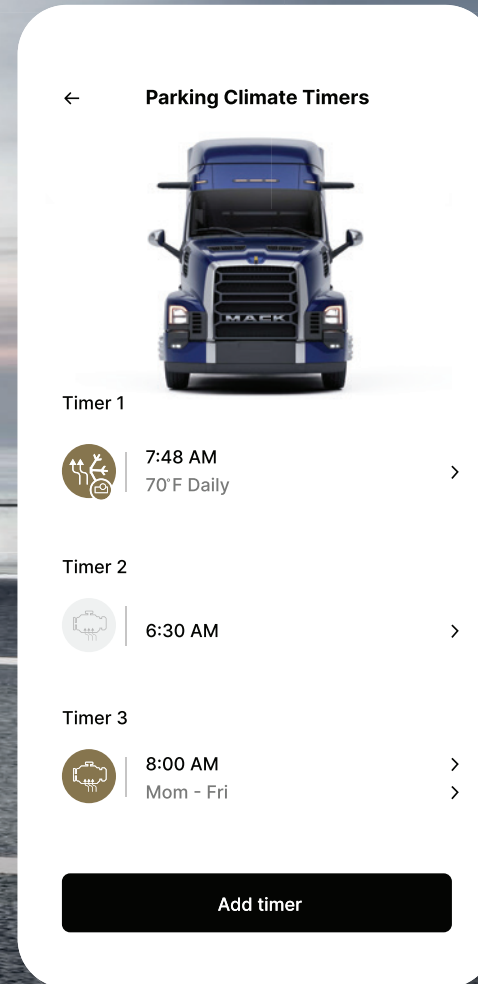
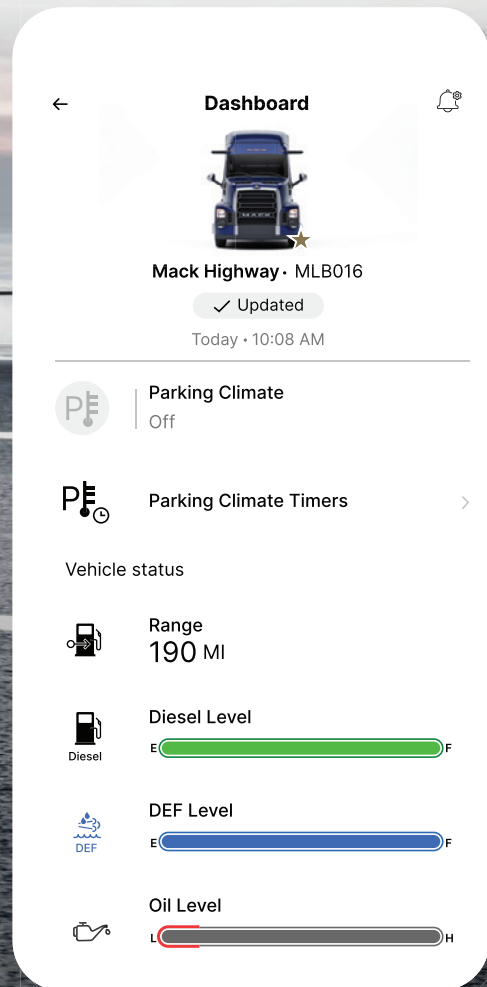

Mack Connect

Connect Mack Pioneer™ to a unified dashboard designed to simplify your operations and drive profitability.

OTA UPDATES

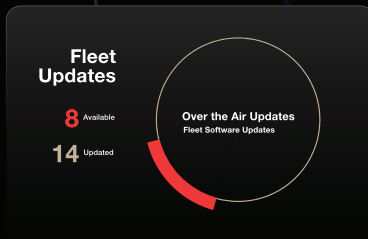

YOUR FLEET

FUEL REPORTING

LOCATION

Track Performance

Use location data to monitor your truck's position history and location in real time and analyze your routes.

Maximize Uptime

Instantly access truck parameter and fault code information to address issues and get your vehicle back on the job quickly.

Simplify Daily Operations

The integrated dashboard is your unified hub to monitor fleet data across a full suite of integrated truck features.

Increase Efficiency

Tracking fuel usage and visualize operating parameters such as road speed settings across your entire fleet in a single hub.

SUPPORT
WHENEVER,
WHEREVER.

THIS IS THE NEW STANDARD.

Mack Support

Get the tools, tips and resources you need to keep your Mack Pioneer™—and your business—running smoothly.

24/7 Roadside Assistance

Our team at Mack OneCall™ provides 24/7 full-service support with a network of experts to keep you and your drivers informed and connected, should you have a problem.

Certified Uptime Dealers

Mack's Certified Uptime Dealers—a large portion of our dealer service network—are identify quick fixes and put your truck in the fast lane for completion.

Investing In Service

The Mack Dealer Network is committed to quick, quality service. That's why our dealers have invested nearly \$600 million since 2010 to expand our number of locations, modernize facilities, and improve access to parts.

Family Experience

Whether you're behind the wheel or managing the fleet, when you run with Mack, you're part of the family. That means you'll always get personalized attention and the support you need.

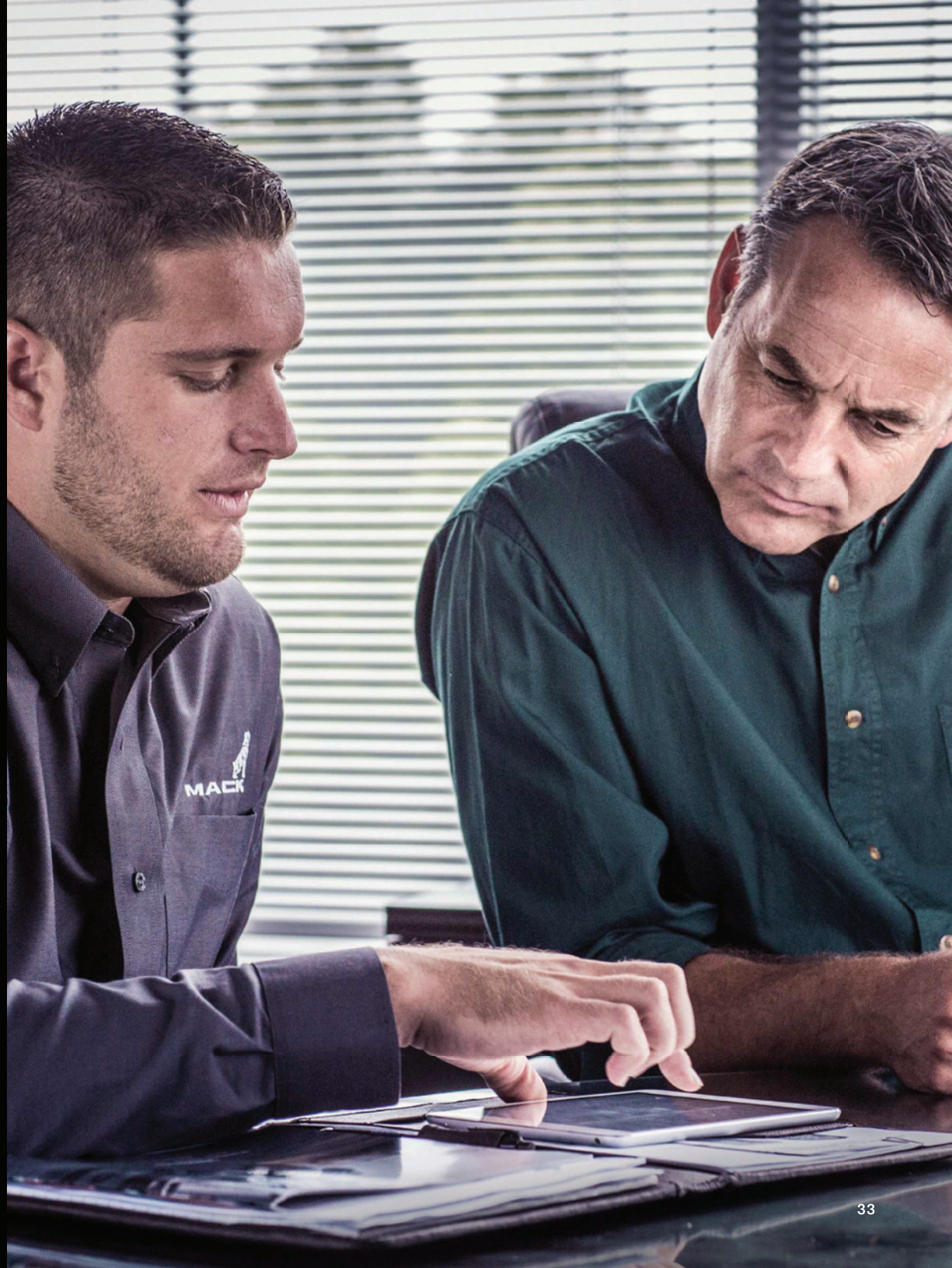

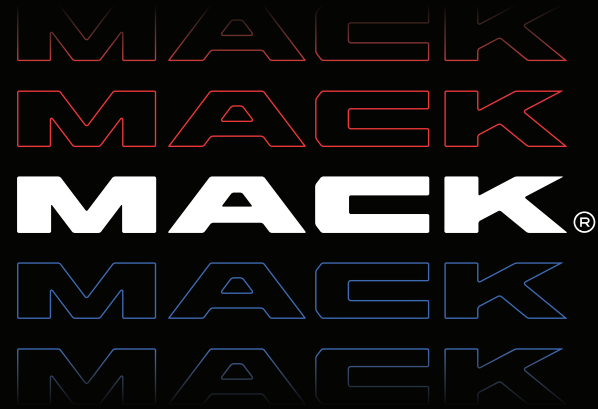

©2025 Mack Trucks, Inc. All rights reserved. Mack, Mack and the Bulldog design, Bulldog and all other marks contained herein are registered trademarks of Mack Trucks, Inc. and/or Mack Trucks, Inc. affiliated companies. All other marks contained herein are the property of their respective owners.

BR-OX-PIO-0425